

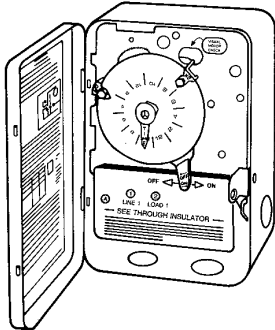

SHAW SUPPLY COMPANY
 1066 East 16th Street
 816-221-0060
 www.shawsupply.com

TIME CLOCKS

INTERMATIC 24-HOUR DIAL TIME SWITCHES SERIES T100



Standard "On-Off" time switches. Provides 1 to 12 "On-Off" operations every day, depending on number of trippers used. Allows timing of 1 to 23 hours. One "On" and one "Off" tripper furnished with each switch. 40 amp. Resistive or inductive each pole, 120-480 volts AC.

INT No.	Switch	Clock Motor Volts, 60 Hz.	Amps Per Pole	HP Rating	Enclosure	Each
T101	SPST	125	40	2	Indoor	\$69.86
T103	DPST	125	40	2	Indoor	77.63
T104	DPST	208/277	40	5	Indoor	81.08

ACCESSORIES

INT No.	Description	Each
156T1978A	Tripper set (1-On, 1-Off).	\$2.60

INTERMATIC 24-HOUR DIAL TIME SWITCHES SERIES T170

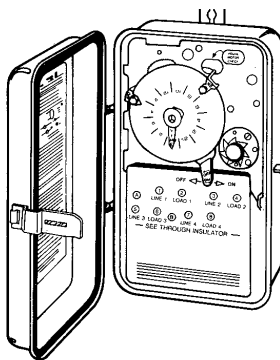

Standard "On-Off" time switches. Has the same applications and performs functions similar to the T100 time switch, plus it allows you to omit operation on Saturday, Sunday or any other selected day(s) of the week. All models equipped with one Cutout Tripper (which also serves as "On" tripper), one "Off" tripper and three skipping screws. 40 amp resistive or inductive each pole, 120-480 volts AC.

INT No.	Switch	Clock Motor Volts, 60 Hz.	HP Rating	Enclosure	Each
T173	DPST	125	2	Indoor	\$109.90
T175	1NO/1NC*	125	2	Indoor	109.90
T1471BR	4PST	125	2	Raintight	171.94
T1472BR	4PST	208/277	5	Raintight	175.69

*Can be wired as SPDT.

ACCESSORIES

INT No.	Description	Each
156T1948A	Tripper set (1-On/1-Off/1-cutout).	\$2.60

INTERMATIC 7-DAY DIAL TIME SWITCHES SERIES T7400B

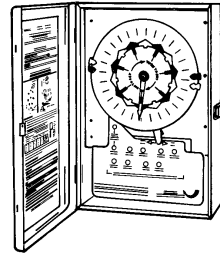

Provides a different program each day of the week. Recommended for heating, air-conditioning, lights, ventilation, pumps, motors and other single to three phase leads. Seven sets of trips supplied with each switch enables you to set a different "On-Off" program each day of the week. Three operations per day maximum. 40 amps resistive or inductive each pole. 120-480 volts AC.

INT No.	Switch	Clock Motor Volts	Enclosure	Each
T7401B	4PST	125	Indoor	\$152.66
T7402B	4PST	208-277	Indoor	159.13

ACCESSORIES

INT No.	Description	Each
156T2548A	Tripper set (7-On, 7-Off).	\$15.61

INTERMATIC ELECTRONIC TIME SWITCHES

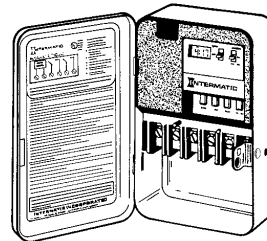

Easy to operate solid-state digital electronic timer. All programming and clock setting is accomplished with the use of two slide switches and four/five pushbuttons. Comes with factory installed industrial grade standard "AA" alkaline battery to provide timekeeping and automatic carry-over for a minimum of 3 years. 120V clock supply. 30A per pole. Indoor rated enclosure.

INT No.	Switch	Description	Set Points	Each
ET101C	SPST	24 hr. time switch.	8 (4 On/Off)	\$133.94
ET103C	DPST	24 hr. time switch.	8 (4 On/Off)	147.38
ET171C	SPST	7 day time switch.	10 (5 On/Off)	185.38
ET173C	DPST	7 day time switch.	10 (5 On/Off)	198.80

INTERMATIC SPRINGWOUND WALL BOX TIME SWITCHES

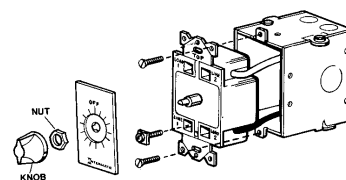

Designed to be used with standard or decora style switch plates. This spring wound, manually set, time switch automatically turns "Off" ventilating fans, heaters, heat lamps, lights, and can operate as a thermostat bypass. Rating: 20 amps, 125VAC, 1 HP; 10 amps, 250VAC, 1 HP; 10 amps, 277VAC; 7 amps, 125VAC tungsten rating S.P.S.T. Mounts in standard 2-1/2" deep switch box.

INT No.	Description	Each
FD12HH	12 hr., w/hold, Ivory.	\$26.07
FD12HHW	12 hr., w/hold, White.	26.07
FD5MI	0-5 min., w/o hold, Ivory.	24.74
FD15MI	0-15 min., w/o hold, Ivory.	22.52
FD30MI	0-30 min., w/o hold, Ivory.	22.52
FD30MW	0-60 min., w/o hold, White.	22.52
FD60MI	0-60 min., w/o hold, Ivory.	22.52
FD60MW	0-60 min., w/o hold, White.	22.52

TIME CLOCKS, PHOTOCONTROLS



SHAW SUPPLY COMPANY
1066 East 16th Street
816-221-0060
www.shawsupply.com

GRASSLIN ELECTRONIC IN-WALL TIMER



Replaces standard wall switch (toggle) to provide automatic control of outdoor or indoor lighting, fans, pumps, office machines, and other types of circuits. The unit can be programmed for 7-ON and 7-OFF events daily or weekly. SPECIFICATIONS: Input; 120VAC, 60 Hz. Switch Rating; 15A Ballast @ 120VAC, 15A Tungsten @ 120VAC, 1800W resistive.

GRS No.	Color	Voltage	Battery Backup	Each
ET724	White	120VAC, 60 Hz.	30 Days	\$25.45
ET724-A	Light Almond	120VAC, 60 Hz.	30 Days	25.45

GRASSLIN MULTI-VOLTAGE GENERAL PURPOSE TIME SWITCH



The GM40 Multi-Volt Series Time Controls are universal, electromechanical time switches which can be field configured for various power supply voltages. The voltage options include 120VAC, 208/240VAC, and 277VAC. Compact NEMA 3R outdoor enclosure features a DPDT switching configuration.

GRS No.	Description	Each
GM40	24-hour, SPDT/DPDT, NEMA 3R outdoor enclosure. Battery backup.	\$53.07
GM40W	7-day (Skip-A-Day/Weekly), SPDT/DPDT, NEMA 3R outdoor enclosure. Battery backup.	81.00

INTERMATIC INDOOR-OUTDOOR CASE

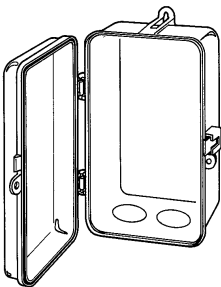

For protecting time switches from rain, sleet, snow and ice. Fits T100, T171, and E1700 series clocks.

INT No.	Each
2T511GA	\$64.37

INTERMATIC FLUSHMOUNT CASE



For concealing mechanism in wall. Body size 9-1/8" high, 6" wide, 4-1/8" deep. Flange size: 11" high, 8" wide. Gray finish. Fits T100 and T171 series clocks.

INT No.	Each
2T304A	\$79.78

INTERMATIC FIXED POSITION MOUNTING PHOTO CONTROLS THERMAL TYPE

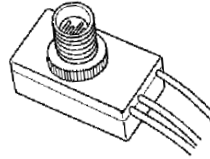

1800 VA Rating. Designed to fit into a standard outlet box, a post lamp or wall packs. K4021C is equipped with a 3/8"-18 threaded side mounting, lock-nut and washer basket.

INT No.	Volts	Standard Package	Each
K4021C	120	12	\$8.79
K4321C	120	12	10.76

*The K4321C is a K4021C with a weatherproof wall plate and neoprene gasket.

INTERMATIC STEM AND SWIVEL MOUNTING PHOTO CONTROLS THERMAL TYPE

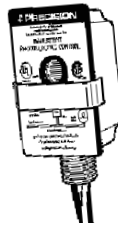

All models are equipped with a light level slide adjustment and provide a 1/2"-14 threaded stem. A washer gasket and locking nut are packaged with each photo control.

INT No.	Volts	Watts Tungsten	VA Ballast	Std. Pkg.	Each
K4221C	120	1800	1000	12	\$12.19
K4236C	120 or 208/277	1800-4150	1000-2300	12	25.05
K4135*	480	7200	4000	12	23.25

*Stem mount only.

INTERMATIC LOCKING TYPE PHOTOCELLS THERMAL TYPE

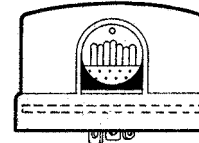

The LC4500 Series provides low cost reliable control for street lighting and other applications requiring a NEMA twist and lock plug connection.

INT No.	Volts	Watts Tungsten	VA Ballast	Std. Pkg.	Each
LC4521C	120	1000	1000	12	\$7.81
LC4523	208/277	1700-2300	1700-2300	12	9.24

LOCKING RECEPTACLE

INT No.	Volts	Watts Tungsten	VA Ballast	Std. Pkg.	Each
K122	--	--	--	6	10.11



SHAW SUPPLY COMPANY
 1066 East 16th Street
 816-221-0060
 www.shawsupply.com

WIRELESS LIGHTING

LUTRON WIRELESS LIGHTING CONTROL

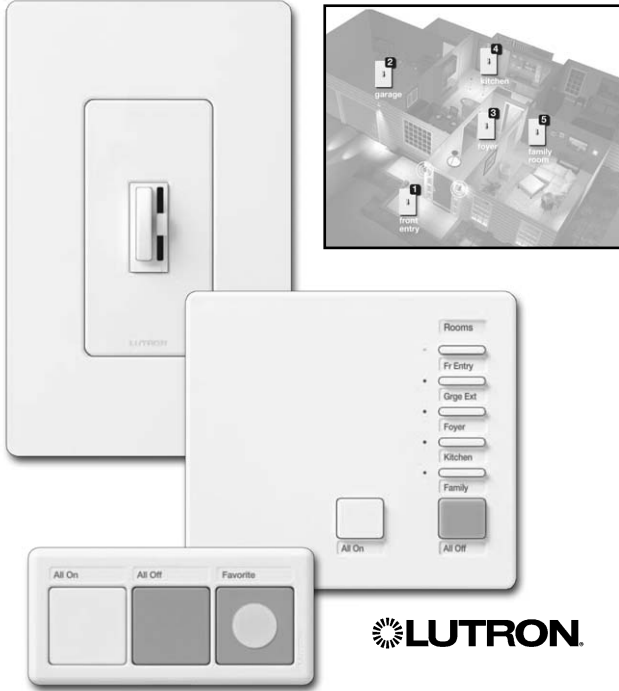

Create a safe path of light to, through, and around the home.

Contractor Benefits:

- maximize profits – entire system installs in under 30 minutes
- pre-programmed – works right out of the box
- new technology – install only 1 dimmer on a 3-or 4-way circuit without replacing other switches
- easy to order – complete system in one package

Builder Benefits:

- differentiates – standardize, gain the competitive edge
- cost effective – small investment, increases home's value
- simple installation – pre-programmed, installs like a switch
- patented RF technology – over a decade of proven reliability

Homeowner Benefits:

- enhances safety – light a path from the car into the home
- saves energy – dimming 50% saves 40% on electricity
- easy to use – press a button, control 5 areas of light



Wireless Controller (1)

Place on the car visor, mount on a wall, or carry it with you. (3) buttons control your lights: "All On" turns system lights on to full bright – "All Off" turns system lights off – "Favorite" turns all 5 dimmers on to their locally set light levels.

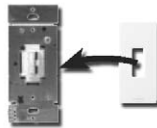

Dimmers (5)

Install like a switch. Adjust light levels with the slider – turn on and off by pressing the button. 600W incandescent loads. Designer Inserts (5) Snap onto dimmer — for use with designer-style wallplates.



Master Control (1)

Plug into a standard wall outlet and place on a table or counter-top. Press a room button to turn dimmer on to locally set slider level. Press "All On" to turn system lights on to full bright or "All Off" to turn lights off.



Central Antenna (1)

Plug into a standard wall outlet and place in a central location (can be under a couch). Central antenna ensures reliable radio frequency communication between all system devices.

LUTRON AURORA® WIRELESS LIGHTING



Aurora includes: (1) Wireless Control, (5) Dimmers, (1) Master Control, (1) Central Antenna.

LUT No.	Description	Each
ARENT1WH	Complete 5 dimmer package. White dimmers.	\$640.00
ARENT1LA	Complete 5 dimmer package. Almond dimmers.	640.00

LUTRON MAESTRO® WIRELESS LIGHTING SAFE ENTRY™ DIMMER WITH WIRELESS CONTROLLER CONTROL THE LIGHTS FROM OUTSIDE THE HOME



Maestro includes: (1) Wireless Control and (1) Dimmer.

LUT No.	Description	Each
MRF600MTHWLA	Wireless dimming package. White.	\$122.98
MRF600MTHWWH	Wireless dimming package. Almond.	122.98

DIMMERS, SPEED CONTROLS



SHAW SUPPLY COMPANY
1066 East 16th Street
816-221-0060
www.shawsupply.com

LUTRON ARIADNI DIMMERS

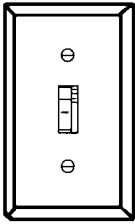

Full range incandescent slide dimming. Classic on/off toggle turns lights on to preset level. Works with standard switch plates.

LUT No.	Description	Each
AY600P*	600W, S.P., 120V.	\$12.87
AY603P*	600W, 3-way, 120V.	17.16
AY10P	1000W, S.P., 120V.	35.75
AY103P*	1000W, 3-way, 120V.	44.23

*Add suffix for color.

COLORS: LA = Light Almond, IV = Ivory, WH = White, BR = Brown.

LUTRON NOVA DIMMERS

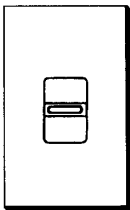

Linear incandescent slide dimming. Color plate included. 120V. U.L. listed.

LUT No.	Description	Each
N600*	600W, slide-to-off, S.P.	\$22.90
N603*	600W, preset, 3-way.	42.65
N1000*	1000W, slide-to-off, S.P.	61.60
N1003*	1000W, preset, 3-way.	78.98
N1500*	1500W, slide-to-off, S.P.	115.30
N2000*	2000W, slide-to-off, S.P.	156.37

*Add suffix for color.

COLORS: GR = Gray, IV = Ivory, WH = White.

LUTRON MAESTRO DIGITAL FADE DIMMERS

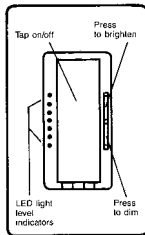

LUT No.	Description	Each
MA600*	Multi-location, 600W, 120V.	\$31.15
MA1000*	Multi-location, 1000W, 120V.	69.36
MALV600*	Multi-location, 600W, magnetic low voltage.	65.07
MAR*	Companion dimmer. Use with multi-location dimmers for 3- or 4-way switch applications. Use up to 9 companions with only one Maestro multi-location dimmer.	21.72

*Add suffix for color.

COLORS: LA = Light Almond, IV = Ivory, WH = White.

LUTRON MAESTRO REMOTE CONTROL DIGITAL FADE DIMMERS

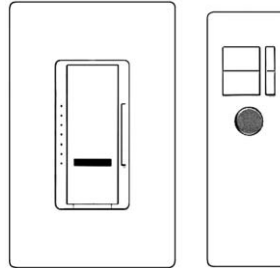

Tap on to favorite levels; tap off. Tap twice for full on. Press, hold and release for gradual fade-to-off. Touch rocker to adjust light level. Gloss or satin finish.

LUT No.	Description	Each
MIR600M*	Multi-location remote control, 600W, 120V.	\$38.25
MIRITFSWH*	Remote control operator.	14.30
MAR*	Companion dimmer for above. Use up to 9 companion with only one Maestro.	21.72

*Add suffix for color.

COLORS: LA = Light Almond, WH = White.

LUTRON MAESTRO DIGITAL FAN CONTROLS

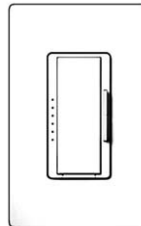

Quiet, 7-speed fan control.

LUT No.	Description	Each
MAFQ4FM*	Multi-location, fan only. Controls up to four fans. One canopy module included.	\$53.63
MAAFQ4*	Multi-location companion fan control. Canopy module required for each fan controlled.	29.67
CMFQ1WH*		31.46

*Add suffix for color.

COLORS: LA = Light Almond, WH = White.

LUTRON MAESTRO DIGITAL FADE DIMMER & FAN CONTROL

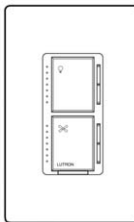

LUT No.	Description	Each
MALFQM*	Multi-location, 300W light. 1 A fan. Includes the necessary dimmer/fan control and canopy module.	\$56.34
MAALFQ35*	Companion fan light control. Use up to two companion controls with only one Maestro Multi-location dimmer/fan control.	31.10

*Add suffix for color.

COLORS: LA = Light Almond, WH = White.



SHAW SUPPLY COMPANY
 1066 East 16th Street
 816-221-0060
 www.shawsupply.com

FLUORESCENT FIXTURES

LENSED TROFFER FLUORESCENT FIXTURES

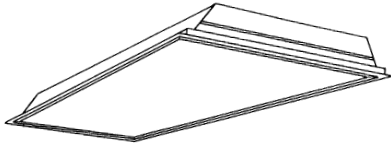

Low profile housing, commercial grade acrylic troffer. Optimized for T8 lamps. 120/277V energy efficient ballast.

MTL No.	Size	Description	Depth	Each
2GR8332AUNV	2 x 4	3 lamp, 32W, T8.	3-3/4"	\$51.20
2GR8432AUNV	2 x 4	4 lamp, 32W, T8.	3-3/4"	52.40
2GR82U6T8AUNV	2 x 2	2 lamp, 32W, U6, T8.	3-3/4"	53.46

MDW No.	Size	Description	Depth	Each
GA432120/277	2 x 4	4 lamp, 32W, T8.	3-1/4"	\$51.95
GA332120/277	2 x 4	3 lamp, 32W, T8.	3-1/4"	51.20
LA2U32120/277	2 x 2	2 lamp, 32W, U6, T8.	4"	53.46
ITGA232SD120/277	1 x 4	2 lamp, 32W, T8.	4-7/8"	48.79

PARABOLIC TROFFER FLUORESCENT FIXTURES

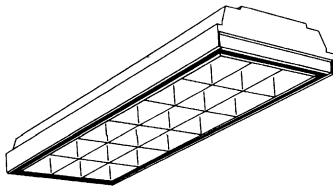

High efficiency, T8, parabolic. 120/277V. Energy efficient ballast. 3" deep louver - spring loaded latches and T-hinges.

MTL No.	Size	Description	Each
2EP3GX332S36IUNV	2 x 4	18 cell. 5-5/8" deep.	\$68.51
2EP3GX2U6T8S33I	2 x 2	9 cell. 5-5/8" deep.	65.50

MDW No.	Size	Description	Each
PGN18332120/277	2 x 4	18 cell. 4-5/16" deep.	\$68.51
N2PG92U32120/277	2 x 2	9 cell. 5-3/4" deep.	65.50

SURFACE WRAP AROUND FLUORESCENT FIXTURES

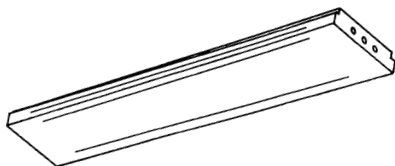

Low profile, commercial grade. Acrylic refractor - shift and lift for ease of relamping. 120/277V energy efficient ballast.

MTL No.	Description	Each
W232UNV	2 lamp, 32W, T8, 8-1/2" W x 2-5/8" D x 48" L.	\$45.93
W432UNV	4 lamp, 32W, T8, 14" W x 2-5/8" D x 48" L.	62.49

MDW No.	Description	Each
WNA10232SSO	2 lamp, 32W, T8, 11" W x 2-3/4" D x 48" L.	\$45.93
WNA14432SSO	4 lamp, 32W, T8, 11" W x 2-3/4" D x 48" L.	62.49

FLUORESCENT STRIPS - SINGLE LAMP

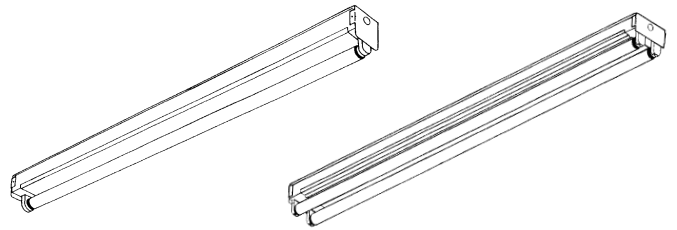

SINGLE LAMP

MDW No.	Size	Lamps	Ballast	Depth	Each
S117SS0UE	24"	1 - 17W, T8.	120/277V	1-3/8"	\$34.63
S125SS0UE	36"	1 - 25W, T8.	120/277V	1-3/8"	34.63
S132SS0UE	48"	1 - 32W, T8.	120/277V	1-3/8"	34.63
S159SS0UE	96"	1 - 59W, T8.	120/277V	2-5/8"	55.71

TWO LAMP

MDW No.	Size	Lamps	Ballast	Depth	Each
S217SS0EU	24"	2 - 17W, T8.	120/277V	2-5/8"	\$34.63
S225SS0UE	36"	2 - 25W, T8.	120/277V	2-5/8"	34.63
S232SS0UE	48"	2 - 32W, T8.	120/277V	2-5/8"	34.63
S232-2-120/277	96"	4 - 32W, T8.	120/277V	2-5/8"	55.71
S259SS0120	96"	2 - 59W, T8.	120V	2-5/8"	55.71
S259SS0277	96"	2 - 59W, T8.	277V	2-5/8"	55.71
F286HOSS0120	96"	2 - 86W, HO.	120V	2-5/8"	70.77
F286HOSS0277	96"	2 - 86W, HO.	277V	2-5/8"	70.77

INDUSTRIAL FLUORESCENT LIGHT FIXTURES SURFACE OR PENDANT MOUNTING

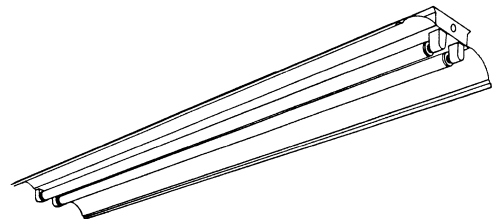

MDW No.	Lamps	Ballast	Each
F22232120/277	2 - 32W, T8.	120/277V	\$42.16
F20259SS0120	2 - 59W, T8.	120V	66.25
F20259SS0277	2 - 59W, T8.	277V	66.25

"THINDEX" SERIES SURFACE MOUNT FLUORESCENT FIXTURES

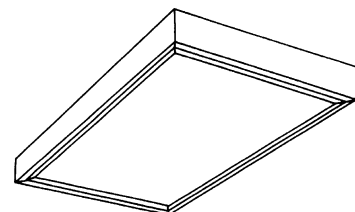

120/277V.

MDW No.	Size	Description	Each
2SPAX2U32120/277	2 x 2	2 lamp, 32W, T8.	\$73.03
2SPAX432120/277	2 x 4	4 lamp, 32W, T8.	87.34

SPECIAL APPLICATION FIXTURES, ACCESSORIES



SHAW SUPPLY COMPANY
1066 East 16th Street
816-221-0060
www.shawsupply.com

KICHLER CABINET LIGHTING

Series 1 features 12 volt, 18 watt Xenon lamps. Lamps run cooler than halogen and have longer life (10,000 hrs.) than halogen.



ALL-IN-ONE

Kit includes fixture, light bulb(s), wiring module and one interconnect cable.

KCH No.	Description	Each
10567WH	2 light, low voltage. 13" length, 14" interconnect cable and wiring module. White finish.	\$64.00
10566WH	3 light, low voltage. 22" length, 21" interconnect cable and wiring module. White finish.	74.16
10585WH	4 light, low voltage. 30-1/2" length, 21" interconnect cable and wiring module. White finish.	91.85



MODULAR

Provides flexibility when designing your lighting application. Use with accessories or combine with the All-in-One kits.

KCH No.	Description	Each
10564	2 light, low voltage (12V). 13" length. (2) Xenon light bulbs included.	\$53.83
10563	3 light, low voltage (12V). 22" length. (3) Xenon light bulbs included.	64.37
10587	4 light, low voltage (12V). 30-1/2" length. (4) Xenon light bulbs included.	82.82

ACCESSORIES

KCH No.	Description	Each
10570WH	Wire module.	\$10.16
10569WH	Master switch.	25.22
10575WH	Plug-in master switch.	26.35
10571WH	9" interconnected cable.	6.40
10572WH	14" interconnected cable.	7.15
10573WH	21" interconnected cable.	7.91
10574CLR	Xenon lamp.	2.11

UNDER CABINET FLUORESCENT FIXTURES

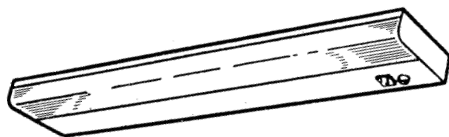

White acrylic plastic lens. Snaps in and out. 1-7/8" deep. Includes rocker switch. 120/277V ballast.

MDW No.	Size	Ballast	Each
SL117SS0RSUE	24"	1 - 17W, T8.	\$51.95
SL125SS0RSUE	36"	2 - 25W, T8.	53.46
SL132SS0RSUE	48"	2 - 32W, T8.	54.96

ENCLOSED & GASKETED FIXTURE



120/277 VAC. Vaportight design. High-impact resistant, reinforced polyester, figerglass housing.

MDW No.	Description	Each
EG232WL120/277	2 lamp, 32W, T8.	\$81.31

FIXTURE ACCESSORIES

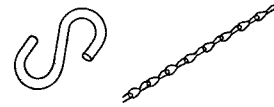

PRICE PER 100

MDS No.	Description	Standard Package	Each
W-11	"S" hook, bright steel.	100-1000	\$.10
W-13	Chain, plated steel, 50 ft. length.	50-500	.29

MIS No.	Description	Each
STHW12	Fixture hanger wire - 12 ft.	\$.95

MDW No.	Description	Each
HRC1	Fixture hanger.	\$2.25

FIXTURE WHIPS

EPC No.	Description	Std. Pkg.	Each
EPW-14-62S	6' 2-14 GA. Solid wire 3/8" conduit.	30	\$7.08
EPW-14-63S	6' 3-14 GA. Solid wire 3/8" conduit.	30	7.71



SHAW SUPPLY COMPANY
 1066 East 16th Street
 816-221-0060
 www.shawsupply.com

FLOOD LIGHTS, AREA LIGHTS

HUBBELL OUTDOOR LIGHTING GLASS WALLPACK



Borosilicate glass refractor. 4 times spacing to mounting height. All units have dark bronze powder paint finish, Quad-Tap® ballasts and lamps included. UL Listed for use in wet locations.

HBL No.	Wattage/ Source	Voltage	Finish	Each
WGH175H	175/MH	120, 208, 240, 277	Bronze	\$146.30
WGH250H	250/MH	120, 208, 240, 277	Bronze	168.56
WGH400H	400/MH	120, 208, 240, 277	Bronze	179.69

HUBBELL OUTDOOR LIGHTING WALLPACK METAL HALIDE



Fixture features borosilicate glass refractor for non-yellowing. 4 to 1 spacing ratio. 120V lamp included. UL Listed for use in wet locations.

HBL No.	Wattage/ Voltage	Finish	Start Temp.	Each
WGH100H	100 MH/120V	Bronze	-20°F	\$144.70
WGH70H	70 MH/120V	Bronze	-20°F	135.17

HUBBELL NRG SERIES OUTDOOR LIGHTING



Full polycarbonate front provides vandal resistance and efficient spread. Lateral coverage is 5 times the typical mounting height of 6-10 feet. Molded-in bronze finish. UL Listed for use in wet locations. Lamp included.

HBL No.	Wattage	Volts	Each
HIGH PRESSURE SODIUM			
NRG301B	50W	120	\$81.10
NRG307B	70W	120	88.25
METAL HALIDE			
NRG350B	50W	120	155.84

HUBBELL PERIMALITER AREA LIGHTS



One piece polycarbonate lens, internally painted for lasting appearance. 6 to 1 spacing to mounting height ratio. Housing is die cast aluminum. Specular reflector, vertical lamp and refractor combine for efficient and uniform perimeter lighting. CSA certified for use in wet locations. Lamp included.

HBL No.	Watts	Lamp Type	Voltage	Each
HIGH PRESSURE SODIUM				
PVL0100S128LP	100	Clear Mogul	Quad/AL (HPF)	\$193.12
PVL0150S128LP	150	Clear Mogul	120/Reactor (NPF)	185.57
METAL HALIDE				
PVL070H128L	70	Clear Mogul	Quad/AL (HPF)	238.60
PVL0175H128LP	175	Clear Mogul	Quad/PLA (HPF)	185.57

STONCO FLOODPAK SERIES HID AREA LIGHTS



The FloodPak is a perfect blend of architectural design and performance. Can be surface mounted in various position. Use it as a cut-off wallpack or tip it up 22.5° for forward throw with semi-cut-off. Tip it up 45° for floodlighting, or turn it over and use it for indirect/accent lighting. UL wet location list for above or below horizontal aiming. Quad tap/with lamp.

STC No.	Description	Each
FPM175MAL8	175W. Metal halide. Quad tap ballast with lamp.	\$159.60
FPL250MAL8	250W. Metal halide. Quad tap ballast with lamp.	212.80

HUBBELL "CUTOFF" WALLPACK



Clear borosilicate glass lens allows shielded lamp to direct main beam downwards. Shielded lamp above a specular hammertone reflector provides beam control, socket is adjustable for deeper shielding. Dark bronze power paint finish. CSA certified for use in wet locations.

HBL No.	Watts	Voltage/ Ballast	Each
METAL HALIDE			
PGS-A175H-128-1	175	Quad/AL (HPF)	\$318.11
PGS-B250H-128-1	250	Quad/PLA (HPF)	364.62

FLOOD LIGHTS, AREA LIGHTS



SHAW SUPPLY COMPANY
1066 East 16th Street
816-221-0060
www.shawsupply.com

HUBBELL MICROLITER FLOODLIGHTS



A compact H.I.D. floodlight for energy efficient outdoor lighting. The Microliter is ideal for floodlighting applications such as building facade, sign lighting, display, as well as general safety and security lighting. Bronze powder coat protective finish. Includes H.I.D. lamp. UL and CSA approved suitable for wet locations.

HBL No.	Watts	Lamp Type	Voltage	Each
NORMAL POWER FACTOR—HIGH PRESSURE SODIUM				
MIC0070S651	70	Coated	120	\$112.98
MIC0150S651	150	Clear	120	106.54
HIGH POWER FACTOR—METAL HALIDE				
MIC0070H358	70	Clear	120/208/240/277	218.09
MIC0100H358	100	Clear	120/208/240/277	222.07
MIC0175H358	175	Clear	120/208/240/277	157.43

HUBBELL MINILITER FLOODLIGHTS



A compact H.I.D. floodlight for energy efficient outdoor light. Utilizes all of the efficient H.I.D. sources, including High Pressure Sodium and Metal Halide. Includes 2 bolt steel trunion with center hole for nipple mount. Bronze powder coat protective finish. Wide, uniform beam for illumination of signs, facades and larger areas. Coverage is four times set back distance. Lamp included. CSA certified to UL 1598. Yoke mount.

HBL No.	Lamp Type/Wattage	Voltage	Each
METAL HALIDE			
MHSY400H468-1	400W MH ED37	Quad Tap	\$259.12
MHSY250H468-1	250W MH ED28	Quad Tap	239.64
MHSY175H468-1	175W MH ED28	Quad Tap	253.23
HIGH PRESSURE SODIUM			
MHSY400S468-1	400W HPS E18	Quad Tap	259.12
MHSY250S468-1	250W HPS E18	Quad Tap	253.23
ACCESSORIES			
HBL No.	Description	Each	
4024C	Slip fitter.	\$28.15	
4041	Mounting bracket.	23.61	

HUBBELL QUARTZLITER FLOODLIGHTS



Standard 1/2" swivel knuckle mounting. Utilizing T-3 tungsten halogen lamps, the Quartzliter luminaire provides low cost illumination for use in sports lighting, automobile outdoor sales areas, sign lighting, security, building and other applications. Gray finish. Less lamp.

HBL No.	Watts	Each
QL505	300/500	\$37.85
QL1505	1000/1500	49.29

HUBBELL NITE-TO-LITE LUMINAIRE

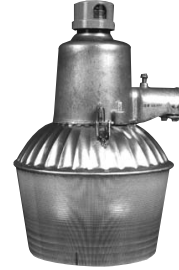

Luminaire package consists of a universal die cast head and ballast, acrylic open bottom refractor, photoelectric control for 120V circuit, 1-1/4" x 24" pipe bracket, and either a 100W HPS or 175W mercury lamp.

HBL No.	Watts	Source	Each
NPU-10S1-5A	100	HPS	\$111.79
NPU-17C1-5A	175	Mercury	94.69



SHAW SUPPLY COMPANY
 1066 East 16th Street
 816-221-0060
 www.shawsupply.com

HIGH BAYS, AREA LIGHTS

HUBBELL LUMASQUARES

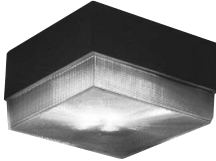

LUMASQUARE I

All polycarbonate compact canopy and ceiling mount luminaire. Designed for both indoor and outdoor applications with mounting heights from 8 to 12 feet. Includes medium base HPS lamp. 120V.

LUMASQUARE II

The vertical burning lamp and the acrylic prismatic refractor make this a very efficient ceiling mount luminaire. Ideally suited for canopies and parking garages. Fully gasketed and weatherproof. Includes medium base HPS lamp. Quad tap, HPF ballast 120, 208, 240, 277V.

LUMASQUARE I

HBL No.	Watts	Each
NRG-401	50	\$157.27

LUMASQUARE II

HBL No.	Watts	Each
NRG-413S8	100	\$289.41

HUBBELL SUPERBAY I HID FIXTURES



Field adjustable lighting distribution patterns and rugged construction make this fixture ideal for new construction or quick and easy retrolighting of existing systems. Will accommodate mounting heights as low as 12' to as high as 30'. 3/4" pendant mount. New quick-on mounting permits one man installation. Furnished with quad tap HPF ballast; 120, 208, 240, 277V. Less lamp.

HBL No.	Description	Each
---------	-------------	------

TANKS ONLY

BLA250S8WH	250W, HPS.	\$115.60
BLA400H8WH	400W, MH.	89.13
BLA400S8WH	400W, HPS.	119.34

REFLECTORS FOR BALLAST TANKS

BLPA2	16" dia. acrylic reflector. Designed for lower wattage and lower mounting heights.	45.48
BLWA	22" dia. acrylic reflector. Designed for low to medium mounting heights and higher wattage fixtures.	58.84
WA2-ENC	22" bottom lens for BLWA Reflector.	38.72
BLLB1	Lo-Bay optic lens.	73.94

ACCESSORIES



HBL No.	Description	Each
HOOK/LOOP	Fixture hanger.	\$6.68

LINEAR FLUORESCENT HIGH BAY



High efficiency T5 & T8 lamps for significant energy savings over HID high bays. Unit may be pendant, chain or surface mounted. Shallow fixture dept 3-7/32". Minimum fixture weight - less load on building structure. Less lamps.

MDW No.	Description	Each
IMX632SS0UE	6-L, 32W, 120/208V, 48".	\$150.58
IMX454SS5HOUE	4-L, 54W T5 HO, 120/208V, 48".	149.07
IM654SS5HOUE	6-L, 54W T5 HO, 120/208V, 48".	173.17

SWIVEL ALIGNER



HBL No.	Description	Standard Package	Each
AL-4	Tapped for 1/2" conduit. Fits 3-1/4" to 4" outlet box. 31° max. from vertical.	50	\$13.36

VAPOR PROOF LIGHTING, WEATHERPROOF HOLDERS



SHAW SUPPLY COMPANY
1066 East 16th Street
816-221-0060
www.shawsupply.com

VAPOR PROOF LIGHTING



Die cast aluminum. Clear globe and guard. Wet location listed vaportites for ceiling or pendant and wall mount.

HBL No.	Description	Each
VBGG-150	Box or pendant mount, 150W max.	\$24.45
VBGG-300	Box or pendant mount, 300W max.	29.26
VWGG-150	Wall mount with box, 150W max.	30.73
VWGG-300	Wall mount with box, 300W max.	37.36

WEATHERPROOF LAMPHOLDERS

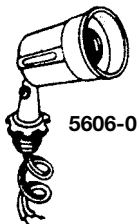

Universal lampholder. Use with medium base PAR lamps to 150W. Supplied with sealing gasket. Silver gray finish.

RCO No.	Standard Package	Each
5606-0	30	\$3.53

HBL No.	Description	Standard Package	Each
103-7	1/2" swivel knuckle mount, 6" leads, 150W max.	10	\$32.04

ARLINGTON SUPPORT FOR OUTDOOR FIXTURES



19.5" x 26". For installing a light fixture and/or GFCI devices outdoors. Openings on both sides of the post for bak-to-back power. Low voltage separator provides for power use on one side and low voltage on the other (phone, security, & cable TV).

ARL No.	Description	Each
GP19BR	19-1/2" post - Bronze.	\$20.50

RACO/BELL CEILING BOX COVER FLAT-BEVELED EDGE

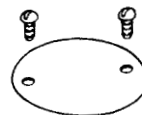

Steel plate with white finish. For 4" box. 5-1/4" diameter.

RCO No.	Standard Package	Each
5653-1	10	\$2.21

RACO/BELL WEATHERPROOF LAMPHOLDER COVERS

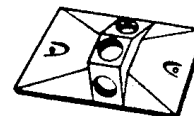
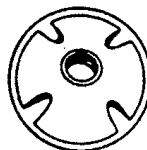

Supplied with sealing gasket, mounting screws and two closure plugs. Silver gray finish. 1/2" hole dia.

RCO No.	Outlet Holes	Standard Package	Each
ROUND			
5197-0	3	20	\$3.09
RECTANGULAR			
5189-0	3	20	2.75

RACO/BELL 4" ROUND WEATHERPROOF OUTLET BOX



Supplied with four closure plugs and grounding screw. 1-1/2" deep.

RCO No.	Outlet Holes	Hole Dia.	Standard Package	Each
5361-0	5	1/2"	16	\$6.89
5372-0	5	3/4"	16	8.35

IF YOU DON'T SEE IT...

CALL US.

Our quotation department will supply pricing on additional fixture brands and types not listed in this catalog.



SHAW SUPPLY COMPANY
 1066 East 16th Street
 816-221-0060
 www.shawsupply.com

EMERGENCY LIGHTS



DUAL LITE LED EXIT SIGN

UV-stable thermoplastic housing. Compact, low-profile design. Long-life LED lamps. Red and green letters. Universal end/ceiling/wall mount. Universal snap-in, chevron arrows. Damp location listed. 120/277 VAC, 60 Hz. operation. Long life, NiCad battery. 2 hour emergency operation.

DUL No.	Description	Each
LXURWE	Universal single or double face.	\$65.57



DUAL LITE COMBINATION EXIT/EMERGENCY LIGHT

UV-stable thermoplastic housing. White or black finishes. 120/277 VAC, 60 Hz. operation. Solid-state charger. Maintenance-free, pure-lead battery. Low-voltage disconnect. Red and green letters.

DUL No.	Description	Each
LTURW	Universal single or double face, exit & emergency light.	\$119.92

DUAL LITE EMERGENCY LIGHTS



LZ2



EZ2

DUL No.	Description	Each
LZ2	Designer Series. 6-volt, 2-lamp fixture. UV-stable thermoplastic housing. White or black finishes. Low profile lampheads. High-output halogen lamps. 120/277 VAC operation standard. Fully automatic, solid-state charger.	\$52.43
EZ2	Commercial. 6-volt, 2-lamp fixture. Easy to install. Compact, low-profile design. Universal mounting plate. Glare-free lampheads. Maintenance-free pure-lead battery. Universal 120/277 VAC operation. Fully automatic, solid-state charger.	52.43

DAMP/WET LOCATION EMERGENCY LIGHT



Maintenance free, sealed lead calcium battery. Supplies 90 minutes of emergency power. 120/277 VAC, includes battery heater. 6 volt, 11 watt. Operating temperature: -4°F to 104°F.

CHL No.	Description	Each
SV16LB-HR	EGRESS E.M. with heater - Black.	\$207.75
SV16LW-HR	EGRESS E.M. with heater - White.	207.75

EXITRONIX LIFE-LITE SERIES EMERGENCY LIGHT



Universal J-box mounting with quick-connect adapter for fast, simple installation. Compact, low profile design. Fully automatic operation. 6-volt premium grade, lead-acid, maintenance-free battery with 10 year expected life. 120/277 VAC operation. Thermoplastic white housing.

EXI No.	Watts for 1-1/2 Hrs.	Voltage	Damp Location	Each
LL90	22	6	Yes	\$24.47

EXITRONIX LED EXIT LIGHT



Easy to install, snap together design. Long life, high output red or green LED's. Injection-molded, high impact thermoplastic white housing. LED lamp life of 25+ years. Universal mount, canopy included. 120/277 VAC dual input.

EXI No.	Each
VEXUBPWBWH	\$24.47

EXITRONIX COMBINATION LED EMERGENCY EXIT SIGNS



Easy to install, snap together design. Injection-molded, high impact thermoplastic white housing. Unique 180° adjustable square lamp heads. Universal J-Box mounting pattern. 90 minute ETL listed emergency run time.

EXI No.	Description	Each
VEXUBPWHEL90	Combination emergency/exit light, LED.	\$54.14
VEXUBPWHEL90R	Same as above plus 8 watt remote capacity.	81.31

EXITRONIX REMOTE EMERGENCY LIGHT



Remote emergency head utilizes a lamp reflector system that can be adjusted 180° horizontally and vertically to direct light exactly where it is needed. Tungsten high performance lamp. 6 watts. High impact white thermoplastic.

EXI No.	Description	Each
VRVITWD	6 volt, tungsten T-5 wedge base. Gasket included for outdoor use.	\$32.38

RECESSED LIGHTING



SHAW SUPPLY COMPANY

1066 East 16th Street

816-221-0060

www.shawsupply.com

ELITE 4" RECESSED MINITURE DOWN LIGHTS 50W—R/PAR20/A19 HOUSINGS



EZ4

EZ4R

ELI No.	Description	Std. Pkg.	Each
EZ4	4", New construction housing with loose socket. Non-I.C.	6	\$11.93
EZ4R	4", Remodel housing with loose socket. Non-I.C.	6	15.11
EX4IC	4", New construction housing with loose socket. I.C. rated.	6	15.11

TRIMS FOR 4" CANS



ELI No.	Description	Lamp Type	Fits:	Std. Pkg.	Each
AF401WWH	Self flange, white baffle, air shut.	50W R/PAR20	EZ4	24	\$8.75
B403WH	Eyeball.	50R20	EZ4	12	12.40

ELITE 6" INCANDESCENT SLOPE CEILING DOWN LIGHTS

I.C. RATED—2/12 TO 6/12 PITCH (9°-27°)

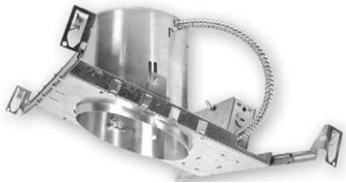

ELI No.	Description	Std. Pkg.	Each
B36IC	6" new construction housing. Accommodates up to 75W PAR30, R30 lamps.	6	\$19.00

TRIM



ELI No.	Description	Lamp Type	Std. Pkg.	Each
B391WWH	White ring, white baffle trim.	75W R/PAR 30	6	\$15.90

ELITE 6" RECESSED DOWN LIGHTS UNIVERSAL IC DOWN LIGHTS

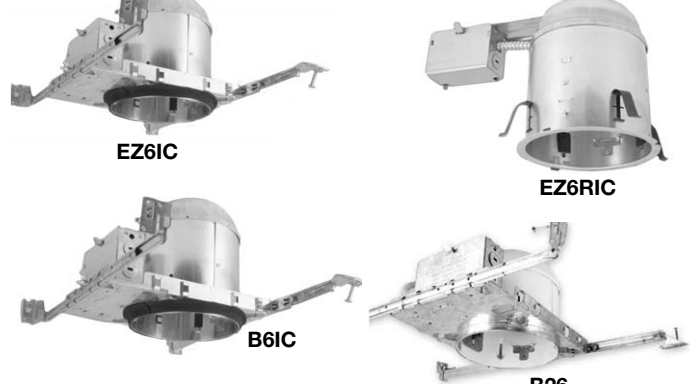

EZ6IC

EZ6RIC

B6IC

B26

Cans all feature air shut gaskets and wago connections.

ELI No.	Description	Std. Pkg.	Each
EZ6ICATW*	6" IC, New construction housing with loose socket.	6	\$7.55
EZ6RICATW*	6" IC, Remodel can with loose socket.	6	9.14
B6ICATW	6" IC, New construction house with socket bracket.	6	7.55
B26IC	6" IC, New construction shallow housing, 5-1/2" height.	6	12.40
B26RIC	6" IC Remodel shallow housing, 5-1/2" height.	6	12.40

*EZ cans feature loose sockets that clip directly to the trim for fast and easy installation. B26 shallow cans use AF637 shallow trims.

TRIMS FOR 6" CANS

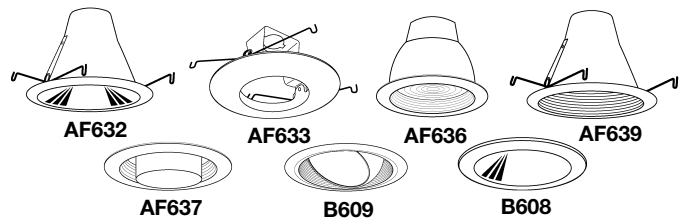

ELI No.	Description	Lamp Type	Fits:	Std. Pkg.	Each
AF632CLWH	Air shut chrome reflector, white ring.	75W R30, 75W PAR30 100W	EZ6/B6	12	\$15.50
AF633WH	R/PAR 30 open trim, white.	R/PAR30	EZ6/B6	12	2.23
AF636WWH	Shower trim - baffle with fresnel lens.	40W A19	EZ6/B6	12	12.72
AF637PWH	Self flange, air shut, black baffle, white ring.	75W R/PAR30	EZ6/B6, B26	12	3.02
AF637WWH	White baffle, white ring.			12	3.02
AF639WH	Self flange, air shut, white baffle, white ring.	75W R/PAR30	EZ6/B6	12	3.02
B608CLWH	Cone chrome reflector, white ring. Regressed white eyeball with white baffle.	105W A21	B6	12	12.72
B609WWH		75W R/PAR30	B6	12	13.52



SHAW SUPPLY COMPANY
 1066 East 16th Street
 816-221-0060
 www.shawsupply.com

RECESSED LIGHTING

ELITE "MAXILUME" 6" ARCHITECTURAL FLUORESCENT DOWNLIGHT



ELI No.	Description	Std. Pkg.	Each
HH6PL2X26EMV	6", 120/277V, uses 4 pin, 26W lamps.	4	\$65.20

TRIM FOR 6" DOWNLIGHT



ELI No.	Description	Standard Package	Each
6501CLWH	6" trim, chrome reflector, white ring.	4	\$30.21

JUNO SLOPED CEILING DOWNLIGHTS

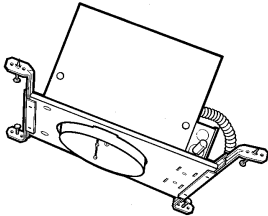

U.L. listed for direct contact with insulated ceilings. Double wall construction. Captive, adjustable 14-1/2" - 30", lock-in-place, reversible, with 1-1/4" staked nail barhangers.

Slope can for 2/12 to 6/12 pitch (9 to 27 degrees).

Super slope can for 7/12 to 12/12 pitch (30 to 45 degrees).

JUR No.	Description	Standard Package	Each
IC926	Slope ceiling can.	4	\$38.71
IC928	Super slope ceiling can.	4	46.64

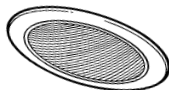

Baffle with white trim ring. Use with 150W PAR38 or 75W PAR30 type lamps.

JUR No.	Description	Lamp Type	Fit Fixture	Std. Pkg.	Each
614B-WH	Black baffle with white trim for IC926.	90W, PAR38 150W, PAR38	IC926, TC926	6	\$27.74
614W-WH	White baffle with white trim for IC926.	90W, PAR38 150W, PAR38	IC926, TC926	12	24.12
604B-WH	Black baffle with white trim for IC928.	90W, PAR38 150W, PAR38	IC928, TC928	6	30.57
604W-WH	White baffle with white trim for IC928.	90W, PAR38 150W, PAR38	IC928, TC928	6	33.33

JUNO MINIATURE RECESSED INCANDESCENT FIXTURES

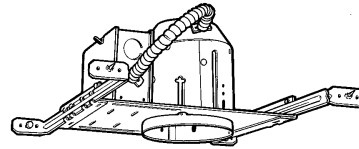

TC1
4-1/4" dia. x 5-1/4" ht.

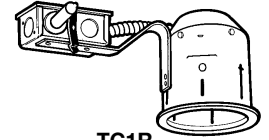

TC1R
4-1/4" dia. x 5-1/4" ht.

TC U.L. listed for recessed ceilings with insulation 3" from fixture and for damp locations. Captive, adjustable 13" - 31", lock-in-place, reversible, with 1-1/4" staked nails barhangers. Remodel housing furnished with ceiling clips.

JUR No.	Description	Standard Package	Each
TC1	4" miniature universal.	6	\$16.73
TC1R	4" miniature remodel.	6	16.71

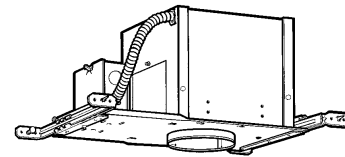

IC1
4-3/8" dia. x 7-1/2" ht.

U.L. listed for direct contact with insulation in insulated ceilings. Captive, adjustable 13" - 31", lock-in-place, reversible, with 1-1/4" staked nails barhangers.

JUR No.	Description	Standard Package	Each
IC1	4" miniature universal, double wall.	4	\$22.29

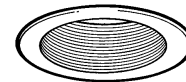

14B-WH



19WH

JUR No.	Description	Lamp Type	Std. Pkg.	Each
14B-ABZ	Mini black baffle aged bronze trim.	50W, PAR20/R20, 40W, K19	12	\$32.36
14B-WH	Mini black baffle with white trim ring.	50W/R20, 50W/PAR20 40W, K19	6	19.87
14W-WH	Mini white baffle with white trim ring.	50W/R20, 50W/PAR20 40W, K19	12	19.87
17WHZ-ABZ	White haze baffle, classic aged bronze.	50W PAR20/R20 60W, K19	12	46.71
18WH	White mini eyeball.	60W/PAR16 40W/R16	12	30.14
19WH	Mini white eyeball.	25W/R14 40W/R16 Intermed. base	6	36.50

RECESSED LIGHTING



SHAW SUPPLY COMPANY

1066 East 16th Street

816-221-0060

www.shawsupply.com

JUNO RECESSED INCANDESCENT 6" FIXTURES

6" UNIVERSALS—I.C.

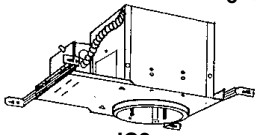

IC2
6-5/8" dia. x 7-1/2" ht.

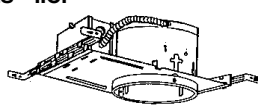

IC21
6-5/8" dia. x 5-3/4" ht.

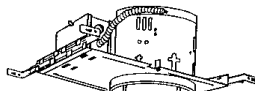

IC22
6-5/8" dia. x 7" ht.

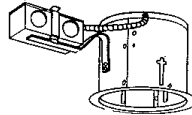

IC22R
6-5/8" dia. x 7" ht.

6" UNIVERSALS—T.C.

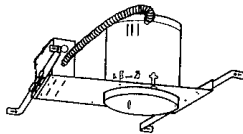

TC2
6-5/8" dia. x 7-1/2" ht.

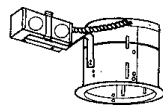

TC2R
6-5/8" dia. x 5-1/4" to
7-1/4" adjustable ht.

U.L. listed for direct contact with thermal insulation in insulated ceilings. Captive, adjustable 13" - 31", lock-in-place, reversible, with 1-1/4" staked nails barhangers. Remodel housings furnished with ceiling clips.

6" UNIVERSALS—I.C.

JUR No.	Description	Standard Package	Each
IC2	6" deluxe universal, double wall.	4	\$23.16
IC21	6" shallow universal.	6	17.66
IC22	6" economy universal.	6	8.98
IC22R	6" economy remodel.	6	13.60

U.L. listed for recessed ceilings with insulation 3" from fixture and for damp locations. Captive, adjustable 13" - 31", lock-in-place, reversible, with 1-1/4" staked nails barhangers. Remodel housings furnished with ceiling clips.

6" UNIVERSALS—T.C.

JUR No.	Description	Standard Package	Each
TC2	6" deluxe.	6	\$9.42
TC2R	6" deluxe remodel.	6	13.59

ROUND TRIMS



21-PW



23B-WH



24B-WH



25B-WH



26C-WH,
27C-WH



229-PB,
229-WH



232C-WH



241-PW



244W-WH



248-WH



250-PB,
250-WH



251-PB,
251-WH



261B-WH

JUR No.	Description	Lamp Type	Fits Fixture Type	Std. Pkg.	Each
21-PW	8" O.D., drop oval, shower/ closet light.	40W/A19	IC2, TC2, TC2R	6	\$21.53
23B-WH	7-1/2" O.D., pin hole, white.	75W/ER30	TC	6	24.08
24B-WH	7-3/4" O.D., stepped baffle, black baffle, white ring.	75W/R30	IC, TC	12	12.45
24W-WH	7-5/8" O.D., stepped white baffle, white ring.	75W/R30	IC, TC	12	12.45
25B-WH	7-3/4" O.D., stepped black baffle, white ring.	150W/R40	TC	12	12.45
25W-WH	7-5/8" O.D., straight white baffle, white ring.	150W/R40	IC, TC	6	12.45
26C-WH	7-5/8" O.D., straight cone, clear alzak, white trim.	150W/BR40	IC, TC	6	19.02
27C-WH	7-5/8" O.D., tapered cone, clear alzak, white trim.	75W/BR30	IC, TC	6	30.98
229-PB	7-3/4" O.D., eyeball, polished brass.	75W/R30	IC, TC	6	45.26
229-WH	7-3/4" O.D., eyeball, white.	75W/R30	IC, TC	6	19.87
232C-WH	7-5/8" O.D., A-lamp reflector, clear alzak, white trim.	150W/A19	IC, TC	6	35.26
241-PW	8" O.D., gasketed, drop opal shower trim, white.	60W/A19 40W/A19	IC, TC	6	18.40
244W-WH	7-5/8" O.D., shallow white baffle, white trim.	PAR30, 65W, BR30	IC, TC	6	22.29
248-WH	7-1/2" O.D., black baffle, white eyeball.	50W/R20/ PAR20	IC, TC	6	40.78
250-PB	Exposed lamp, 8" O.D., polished brass.	75W/R30	IC, TC	6	19.46
250-WH	Exposed lamp, 8" O.D., black baffle, white ring.	75W/R30	IC, TC	6	5.06
251-PB	Exposed lamp, 8" O.D., polished brass.	150W/R40	TC	6	19.46
251-WH	Exposed lamp, 8" O.D., white.	150W/R40	TC	6	8.97
261B-WH	7-1/2" O.D., wallwasher, black baffle, white ring.	75W/R30	TC	6	41.19



SHAW SUPPLY COMPANY
 1066 East 16th Street
 816-221-0060
 www.shawsupply.com

RECESSED, TRAC-LIGHTING

JUNO MINIATURE LOW-VOLTAGE RECESSED INCANDESCENT FIXTURES WITH MAGNETIC TRANSFORMERS

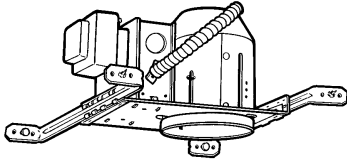

TC44
4-1/4" dia. x 5-1/4" ht.

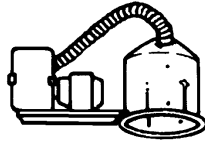

TC44R
4-1/4" dia. x 5-1/4" ht.

JUR No.	Description	Standard Package	Each
TC44	4" low voltage universal.	4	\$65.96
TC44R	4" low voltage remodel.	6	65.96



JUR No.	Description	Lamp Type	Std. Pkg.	Each
441W-WH	Lensed shower trim, 50W/MR16, white, 35° vertical body.	50W/MR16	12	\$41.75
444B-WH	Black baffle with white trim ring.	50W/MR16	6	26.01
444W-WH	White baffle with white trim ring.	50W/MR16	12	26.91
445-WH	Down light or adjustable slot aperture.	50W/MR16	12	33.33
447C-WH	Clear alzak, white trim, 35° vertical adj., 3-3/8" aperture.	50W/MR16	12	33.33
448-WH	Eyeball, white with black baffle.	50W/MR16	6	40.78

JUNO RECESSED STEP LIGHT



U.L. listed for damp locations and direct contact with insulation.

JUR No.	Description	Std. Pkg.	Each
ICTC113-840WH	Housing: 3-3/8"H, 3-7/8"D, 7-1/4"L; Trim: 8" x 4-1/2" white aluminum louvered face, 25W max.	6	\$24.41

JUNO TRAC-MASTER LIGHTING

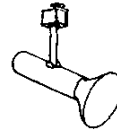

T301



T308

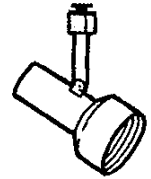

**T303
T305
T307**

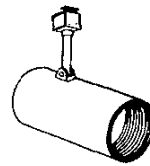

**T311
T313
T315**

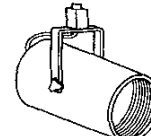

T317

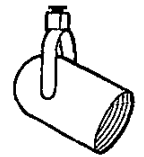

**T326
T327
T328**

The trac-master system offers great versatility in both commercial and residential applications. It features solid copper buss bars, low profile, and aluminum extruded channel for strength. Juno Light trac fixtures feature one hand installation and built-in on/off switch. All components have visual and mechanical polarity arrows to assure correct installation.

JUT No.	Description	Color	Std. Pkg.	Each
T301WH	Universal trac light with switch, 30W R20 to 150W R40, 250W PAR38.	White	12	\$33.25
T308WH	Mini universal (metal) with switch, 30-50W R20 to 150W PAR38/R40.	White	4	31.32
T303B-WH	Mini baffle step cylinder with switch, 30-70W R20.	White	4	37.77
T305B-WH	Step cylinder with switch and black phenolic baffle, 75W R30.	White	4	44.16
T307B-WH	Step cylinder with switch and black phenolic baffle, 150W R40, 150W PAR38.	White	4	58.65
T311WH	Flat back cylinder with switch and black phenolic baffle, 25W R14 or 40W R16, intermediate screw base.	White	4	35.31
T313B-WH	Flat back cylinder with switch and black phenolic baffle, 30-75W R20.	White	4	37.91
T315B-WH	Flat back cylinder with switch and black phenolic baffle, 75W R30.	White	4	44.16
T317B-WH	Flat back cylinder with switch and black phenolic baffle, 150W PAR38/R40.	White	4	58.25
T326B-WH	Round back cylinder with switch and black phenolic baffle, 30-75W R20.	White	4	41.63
T327B-WH	Round back cylinder with switch and black phenolic baffle, 75W R30.	White	4	46.68
T328B-WH	Round back cylinder with switch and black phenolic baffle, 150W PAR30/R40.	White	4	60.05

TRAC-LIGHTING



SHAW SUPPLY COMPANY

1066 East 16th Street

816-221-0060

www.shawsupply.com

JUNO TRAC-MASTER LIGHTING (Cont'd.)

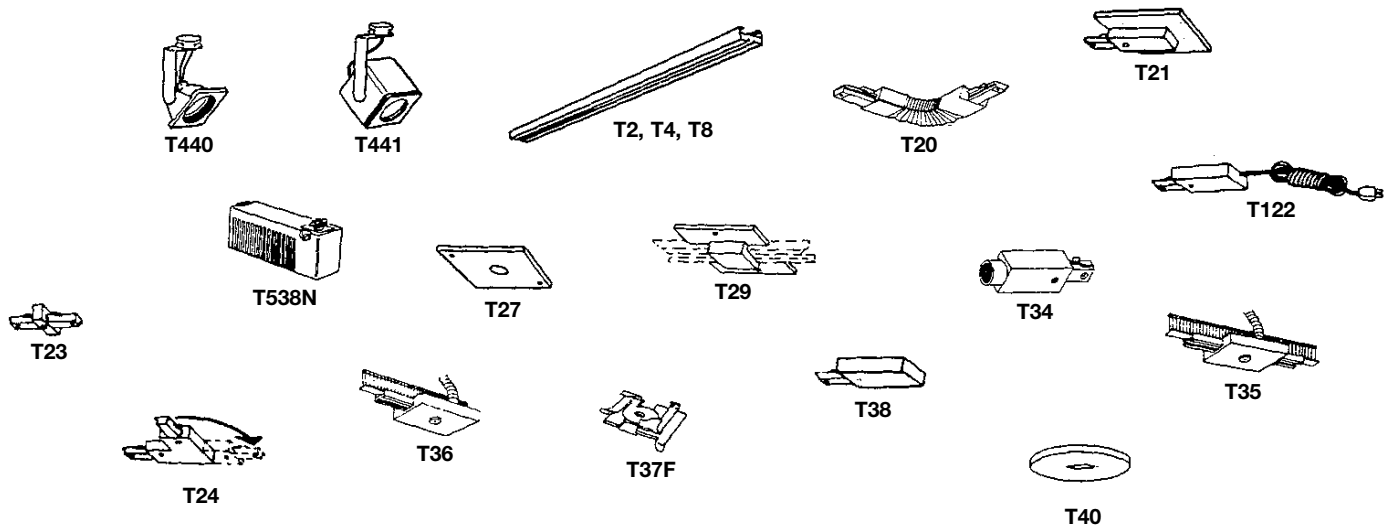

JUT No.	Description	Color	Std. Pkg.	Each	JUT No.	Description	Color	Std. Pkg.	Each
*LOW VOLTAGE MINI-SPOTLIGHTS					SURFACE TRAC AND TRAC ACCESSORIES—WHITE FINISH (Cont'd.)				
T440WH	Open back mini spotlight, 12V, 20-75W MR16, 2-1/2" sq. x 2-1/4" deep.	White	4	\$24.94	T27WH	Outlet box cover, use with T24 and T38 for outlet box electrical feed.	White	12	\$5.52
T441WH	Cube mini spotlight, 12V, 20-50W MR16, 2-1/2" sq. x 2-3/4" deep.	White	4	28.46	T29WH	Floating electrical feed, permits mounting at any point of trac at outlet box, includes floating conn. and outlet box cover plus extra trac dead end.	White	12	11.65
T538NWH	75VA solid state electronic power pack transformer, 12V. Use with 20-75W 12V lamps. 2-5/8"H x 5-7/8"W x 1-5/8"D.	White	4	64.44	T34WH	Conduit adapter, for surface wiring, uses standard 1/2" connector.	White	6	17.09
SURFACE TRAC AND TRAC ACCESSORIES—WHITE FINISH					T35WH	T-Bar adjustable joiner feed, joins 2 trac sections to make a 90° angle or straight run, wiring compartment contains standard 1/2" K.O.'s, feeds from above when directly above trac.	White	6	23.94
T2WH	2' trac, one circuit, dead end included, 19-7/8" long.	White	6	16.56	T36WH	T-Bar end feed, wiring compartment contains std. 1/2" K.O.'s, feed surface trac from above, when T-bar is directly above trac.	White	6	19.82
T4WH	4' trac, one circuit, dead end included, 43-7/8" long.	White	6	36.85	T37F	T-Bar attachment clip, to attach trac to inverted tee ceiling, use 2 for 4' trac and 3 for 8' or 12' trac.	White	12	1.86
T8WH	8' trac, one circuit, dead end included, 91-7/8" long.	White	6	60.05	T38WH	Live end feed connector, feed trac from above with flexible conduit, BX etc. and for end feed in pendant systems, use standard 1/2" connector.	White	12	10.91
T20WH	Accordian adjustable joiner, joins 2 trac sections, can flex to 90°.	White	6	25.14	T40WH	Mono-point adapter, all trac fixtures may be used with T40 for direct mount to outlet box.	White	12	12.37
T21WH	Feed end connector and outlet box cover, for outlet box feed.	White	12	14.50					
T22WH	Cord and plug connector, comes with 15' 2-wire cord and includes surface wire retainers and in-line switch, 10 amp maximum.	White	6	26.07					
T122WH	Same as above but with 3 wires, no switch, 12 amp maximum.	White	12	26.07					
T23WH	Miniature straight connector, joins 2 trac sections end to end.	White	12	7.98					
T24WH	Adjustable connector, joins two trac sections to make a 90° angle or straight run, for outlet box feed T27 cover plate also required.	White	12	16.29					

*NOTE: Mini-Spots require L.V. transformer No. T538.



SHAW SUPPLY COMPANY
 1066 East 16th Street
 816-221-0060
 www.shawsupply.com

FLUORESCENT BALLASTS

JUNO TRAC 12[®] LOW VOLTAGE TRACK LIGHTING

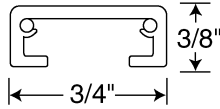

Miniature low voltage system that combines the 20-amp capacity with an extremely miniature engineered plastic profile. The system operates off of remotely located or in-line 12 or 24-volt transformers. A maximum of 240 watts (12 volts) or 480 watts (24 volts) can be placed per circuit or track. Key features include; 12 gauge solid copper conductors, thermoplastic ultra-miniature 3/8" H x 3/4" W profile, accepts all standard Trac 12 lampolders.

Sections include end-feed connector, dead end and mounting hardware. End-feed connector converts to straight connector when joining multiple track sections.

JUR No.	Description	Standard Package	Each
TL2WH	2 ft. track, white finish.	1	\$10.31
TL4WH	4 ft. track, white finish.	1	16.36
TL6WH	6 ft. track, white finish.	1	24.01
TH8WH	8 ft. track, white finish.	1	31.45

TRAC 12[®] CONNECTOR/LAMPOLDERS/LAMPS

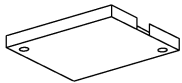

TL21



TL900

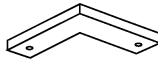

TL24

JUR No.	Description	Standard Package	Each
TL21	Outlet box/T-bar ceiling canopy feed.	12	\$8.78
TL24	Right angle joiner.	12	8.91
TL201	Xenon lampholder. Minimum profile and produces a white light that approximates the color of halogen. Up to 20,000-hr. lamp life and does not require fixture lenses or special handling. 3W-10W.	24	3.72
TL900	T 3-1/4" Xenon wedge base. 12V-3W.	48	1.80
TL901	T 3-1/4" Xenon wedge base. 12V-5W.	48	1.80
TL903	T 3-1/4" Xenon wedge base. 12V-10W.	48	2.13

TRAC 12[®] DIRECT WIRE ELECTRONIC TRANSFORMER

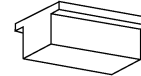

JUR No.	Description	Std. Pkg.	Each
TL546	150W canopy transformer. 12V transformer for loads between 50-150 watts. Mounts over standard 120-volt ceiling outlet boxes and can end-feed one track sections.	4	\$109.46

TRAC 12[®] REMOTE MOUNT MAGNETIC TRANSFORMERS OUTPUT VOLTAGE — 12V



JUR No.	Total Watts	# Circuits/ Watts Per	Dimensions, H x W x D, In.	Std. Pkg.	Each
TL554BL	150	1 / 150	8 x 3-5/8 -3-1/2	1	\$96.49
TL549BL	240	1 / 240	7-7/8 x 4-3/8 x 4	1	130.74
TL550BL	480	2 / 240	11-3/8 x 5 x 5	1	168.31

FLUORESCENT BALLASTS



SHAW SUPPLY COMPANY

1066 East 16th Street

816-221-0060

www.shawsupply.com

FLUORESCENT BALLASTS



ELECTRONIC FLUORESCENT BALLASTS

SYL No.	Primary Lamp Type	No. of Lamps	Input Voltage	Std. Pkg.	Each
QTP2X32T8UNVNSNC	32W/T8	2	120/277	10	\$17.84
QTP3X32T8UNVNSNC	32W/T8	3	120/277	10	19.47
QTP4X32T8UNVNSNC	32W/T8	4	120/277	10	21.09
QTP2X59T8UNVNSNC	59W/T8	2	120/277	10	44.32

Standard Package: 6.

MAGNETIC BALLASTS—FOR REPLACEMENT USE ONLY

SYL No.	Lamp Type	Watts	Line Voltage	Min. Start Temp.	Each
MB2X40120RSSRNK	(2) 40T12/RS	40-34	120	+50°F	\$15.38
MB2X40277RSSRNK	(2) 40T12/RS	40-34	277	+50°F	16.24
MB2X96120ISSRNK	(2) 96T12	75	120	+50°F	28.40
MB2X96277ISSRNK	(2) 96T12	75	277	+50°F	28.72
MB2X96HO120RSSRN	(2) 96T12HO	110	120	+50°F	46.48
MB2X96HO277RSSRN	(2) 96T12HO	110	277	+50°F	47.58

HID BALLAST KITS

SYL No.	Description	Each
BALLAST AND LAMP KITS — METAL HALIDE		
M175ULAMPSUPER5	175W, M-H 5-tap w/lamp.	\$83.39
M250ULAMPSUPER5	250W, M-H 5-tap w/lamp.	96.13
M400ULAMPSUPER5	400W, M-H 5-tap w/lamp.	106.82
M1000LAMPSUPER5	1000W, M-H 5-tap w/lamp.	204.34
M1500LAMPQUADKIT	1500W, M-H quad tap w/lamp.	213.00
M1500LAMP480KIT	1500W, M-H 480V w/lamp.	213.00

BALLAST KIT ONLY W/O LAMP — METAL HALIDE		
M70/120/277KIT	70W, H-H 120/277 kit.	90.27
M100/120/277KIT	100W, H-H 5-tap kit.	88.95
M175SUPER5KIT	175W, H-H 5-tap kit.	53.59
M250SUPER5KIT	250W, H-H 5-tap kit.	66.58
M400SUPER5KIT	400W, H-H 5-tap kit.	66.58
M1000SUPER5KIT	1000W, H-H 5-tap kit.	115.04
M1500QUADKIT	1500W, H-H quad kit.	
M1500/480KIT	1500W, H-H 480V kit.	186.28

BALLASTS AND LAMP KITS — HPS		
LU100ECOMULTIKIT	100W, HPS quad kit w/lamp.	106.82
LU15055ECOLAMPKT	150W, HPS quad kit w/lamp.	113.14
LU250ECOLAMPSP5	250W, HPS 5-tap kit w/lamp.	123.90
LU400ECOLAMPSP5	400W, HPS 5-tap kit w/lamp.	138.93
LU1000LAMPSP5	1000W, HPS 5-tapkit w/lamp.	337.94

BALLAST KIT ONLY W/O LAMP — HPS		
LU50/120/277KIT	50W, HPS 120/277 kit.	87.42
LU70/120/277KIT	70W, HPS 120/277 kit.	87.69
LU100/120/277KIT	100W, HPS 120/277 kit.	90.78
LU100MULTIKIT	100W, HPS quad kit.	90.78
LU150/120/277KIT	150W, HPS 120/277 kit.	95.51
LU150MULTIKIT	150W, HPS quad kit.	95.51
LU250SUPER5KIT	250W, HPS 5-tap kit.	96.16
LU400SUPER5KIT	400W, HPS 5-tap kit.	117.60
LU1000SUPER5KIT	1000W, HPS 5-tap kit.	192.66

QUICKTRONIC CF – DUAL MUNT T4 COMPACT FLUORESCENT BALLASTS



DUAL MOUNT CF UNIVERSAL—NORMAL BALLAST FACTOR

SYL No.	Prod. No.	Input Voltage (VAC)	Lamp Type	No. of Lamps	Each
QTP1/2x13CF/UNVD	51810	120-277	13W DD/E, T/E	1	\$33.87
			13W DD/E, T/E	2	
QTP1/2x18CF/UNVD	51811	120-277	18W DD/E, T/E	1	33.87
			18W DD/E, T/E	2	
QTP2x26/1x42/32C	51812	120-277	26W DD/E, T/E	1	33.87
			26W DD/E, T/E	2	
QTP2X26/32/42CF	51843	120-277	32W DT/E	1	52.08
			26W DT/E	2	
			32W DT/E	2	
			42W DT/E	2	
			57W DT/E	1	
			70W DT/E	1	

PROSTART T5HO UNV—NORMAL BALLAST FACTOR

SYL No.	Product No.	Input Voltage (VAC)	Lamp Type	No. of Lamps	Each
QTP1X54T5HO/UNVP	49121	120-277	FP54T5HO	1	\$62.14
QTP2X54T5HO/UNVP	49131	120-277	FP54T5HO	2	61.55
QTP4X54T5HO/UNVP	49161	120-277	FP54T5HO	4	77.31

HID BALLAST IGNITORS FOR HIGH PRESSURE SODIUM

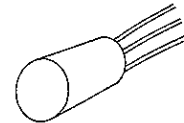

14" lead length.

UNV No.	Lamp	Each
HPS150-3A	35W/S76, 50W/S68, 70W/S62, 100W/S54, 150W/S55.	\$51.59
HPS400-3A	150W/S56, 200W/S66, 250W/S50, 400W/S51.	52.18
HPS1000-4B	1000W/S52.	52.18

FLUORESCENT EMERGENCY BALLAST 120/277V

SID No.	Description	Each
S35F	For use with most 17W - 40W single pin or bipin fluorescent lamps. Operates 1 lamp in the emergency mode for a minimum of 90 minutes.	\$57.06



SHAW SUPPLY COMPANY
1066 East 16th Street
816-221-0060
www.shawsupply.com

SYLVANIA LIGHTING

SYLVANIA

SEE THE WORLD IN A NEW LIGHT



A Century of Leadership in Lighting

For 100 years, Osram Sylvania has been a leader in the development of innovative lighting. With over 3000 branded products to choose from, Sylvania offers a variety of products for a multitude of lighting applications. Each one designed and manufactured to the highest possible standards.



SYLVANIA BALLASTED COMPACT DULUX FLUORESCENT LAMPS MEDIUM BASE — INTEGRAL 120V BALLAST



The DULUX EL® family of compact fluorescent lamps offer long life and energy efficiency in a broad range of shades and wattages. Sylvania DULUX provide you with longer life, high quality lighting, and comfortable lighting levels. DULUX offers a range of products to replace your older and typical incandescent lamps, while lasting up to ten times longer. 120 volt operation.

- Saves 75% of energy compared to similar lumen output incandescent lamps
- Variety of shapes and wattages to satisfy most applications
- 6000 – 12,000 hour average rated lamp life
- 2700k – warm white deluxe, similar to incandescent
- 3000k – soft white, similar to halogen lamps

SYL No.	Product Number	Description	Replaces	Std. Pkg.	Each
CF13ELMICROMINI*	29727	Micromini, 13W, spiral-twist, 12,000 Hrs., color, 3000k.	60W	12	\$5.57
CF20ELMICROMINI*	29728	Micromini, 20W, spiral-twist, 12,000 Hrs., color, 3000k.	75W	12	7.16
CF23ELMICROMINI*	29729	Micromini, 23W, spiral-twist, 12,000 Hrs., color, 3000k.	100W	12	7.55
CF27ELTWIST	29390	Dulux 27W, spiral twist, 10,000 Hrs., color, 3000k	100W	6	8.19
CF28EL3WAYTWIST	29349	Dulux 3-way (28-19-12W), 6000 Hrs., color, 3000k	30-70-100W	6	12.32
CF15ELBR30D	29465	Dulux 15W, R30 reflector, dimmable, color, 2700k	65BR30	6	18.84
CF16ELBR30	29590	Dulux 16W, R30 reflector, color, 3000k	65BR30	6	7.95
CF20ELBR40	29363	Dulux 20W, BR40, color, 3000k	75BR40	6	8.67

* New Micromini Lamps feature new smaller size and longer life – 12,000 hours.

SYLVANIA BALLASTED COMPACT DULUX FLUORESCENT LAMPS DECORATIVE



Electronic compact fluorescent lamps. Saves 75% in energy compared to similar lumen output incandescent lamps. Variety of shapes and wattages to satisfy most applications. 6000 – 10,000 hour average rated lamp life. 2700k – warm white deluxe, similar to incandescent. 3000k – soft white, similar to halogen lamps.

SYL No.	Product Number	Description	Replaces	Std. Pkg.	Each
CG9ELG253K1BL	29495	Dulux EL, 9W, G25 Cover, Med. base, 6000 Hrs., 3000k.	40G25	6	\$28.85
CF14ELG830MED	29195	Dulux, 14W, G30 Cover, Med. base, 6000 hrs. 3000k.	60G30	6	7.95
CF4ELDECOCAND	29121	Dulux, 4W Flame shape, Cand. base, 6000 hrs. 3000k.	16W candelabra	6	7.16
CF7ELDECOMED	29167	Dulux, 7W, Flame shape, Med. base, 6000 hrs. 3000k.	30W med.	6	7.16



SHAW SUPPLY COMPANY
 1066 East 16th Street
 816-221-0060
 www.shawsupply.com

SYLVANIA LIGHTING

SYLVANIA CAPSYLITE - TUNGSTEN HALOGEN LAMPS



Sylvania Capsylite® halogen PAR lamps are the perfect choice for a wide variety of general illumination, task and accent light applications. Most Capsylite and Capsylite SPL lamps can be used indoors or out, in a broad range of downlight, track and recessed ceiling mounted fixtures. This quality "high-end" light adds to the appeal of merchandise in store, showroom and gallery displays. In addition, their long life and energy efficiency make Capsylite lamps ideal for use in residential, commercial and industrial buildings.

SYL No.	Product Number	Description	Std. Pkg.	Each
50PAR20HALNFL30	14502	PAR20, 120V, med. base.	15	\$6.11
50PAR30CAPNFL25	14527	PAR30, 120V, med. base.	15	6.22
50PAR30LCAPWFL50	14537	PAR30LN, 120V, med. base, long neck.	15	6.74
75PAR30CAPNFL25	14603	PAR30, 120V, med. base.	15	6.11
75PAR30CAPSPLNFL	14627	PAR30, 130V, med. base.	15	6.30
75PAR30LCAPNFL25	14769	PAR30LN, 120V, med. base, long neck.	15	6.07
90PAR38CAPFL30	14577	PAR38, 130V, med. base.	15	6.11
90PAR38CAPSPLFLCVP	14647	PAR38, 130V, med. base.	6	5.50
120PAR38CAPSPL/S	14874	PAR38, 130V, med. base.	15	13.68
120PAR38CAPFL30	14861	PAR38, 130V, med. base.	15	10.37

SYLVANIA TRU-AIM HALOGEN DISPLAY LAMPS 12 VOLT



Sylvania TRU-AIM family of halogen MR16 and MR11 reflector lamps provides the widest variety of extremely compact and highly directional light sources in the industry.

SYL No.	Product Number	Description	Std. Pkg.	Each
50MR16SP10C	58325	50W, Spot beam, (Ext).	25	\$3.99
50MR16NFL25C	58326	50W, NFL beam, (Exz).	25	3.80
50MR16FL35C	58327	50W, Flood beam, (Exn).	25	3.53

SYLVANIA ROUGH SERVICE/VIBRATION SERVICE LAMPS



SYL No.	Product Number	Description	Std. Pkg.	Each
100ARS2RP	13002	IF, 130V, A19, Rough service, 1000 hrs.	24	\$1.32
100A21VS	13218	IF, 130V, A19, Vibration service, 1000 hrs.	48	5.37
100ARSXL	12559	IF, 130V, A19, rough service, long life - 5000 hrs.	24	2.58

SYLVANIA 3-WAY INCANDESCENT LAMPS SOFT WHITE



SYL No.	Product Number	Description	Std. Pkg.	Each
30100A21WRP	19385	30, 70, 100W, med. base.	12	\$4.94
50150A21WRP	18060	50, 100, 150W, med. base.	12	4.70
50250A21WRP	19404	50, 200, 250W, med. base.	12	6.52
100300PS25RP*	14374	100, 200, 300W, mogul base.	12	9.34

*Inside frost.

SYLVANIA LIGHTING



SHAW SUPPLY COMPANY

1066 East 16th Street

816-221-0060

www.shawsupply.com

SYLVANIA GENERAL PURPOSE INCANDESCENT LAMPS

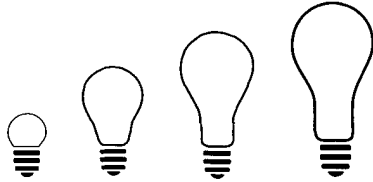

SYL No.	Product Number	Description	Std. Pkg.	Each
6S6CL	16960	S6, 120V, clear, cand. base.	24	\$2.70
7C7	13608	C7, 120V, clear, cand. base.	120	2.14
15A15	10038	A15, 130V, IF, med. base.	120	3.24
15T6145V	18078	T6.5, 14.5V, clear, med. base.	120	7.97
20T6.5CD/IF	18144	T6.5, 120V, IF, D.C. base.	60	10.89
20T6.5/IF	18143	T6.5, 120V, IF, intermed. base.	60	4.21
25A/W/RP	10562	A19, 120V, white, med. base.	24	2.60
40A/34/SS	11058	A19, 120V, frost, med. base.	48	1.69
40A15/CL/BL	10129	A15, 120V, clear, med. base.	12	2.45
60A/52/SS	11376	A19, 120V, frost, med. base.	48	.46
60A/CVP	10489	A19, 130V, frost, med. base.	24	.41
75A/67SS	11377	A19, 120V, frost, med. base.	48	.46
75A/CL	12500	A19, 120V, clear, med. base.	120	2.50
100A/90/SS	11378	A19, 120V, frost, med. base.	48	.46
100A/CL	12529	A19, 120V, clear, med. base.	120	.62
100A	11375	A19, 130V, frost, med. base.	48	.48
150A21/135/SS	12820	A21, 120V, frost, med. base.	48	3.13
200A21/135/CL/RP	15476	A21, 120V, clear, med. base.	12	4.84
300M/CL	15742	PS30, 120V, clear, med. base.	60	6.30
300M/IF	15737	PS30, 120V, frost, med. base.	60	6.81

SYLVANIA DECORATIVE LAMPS

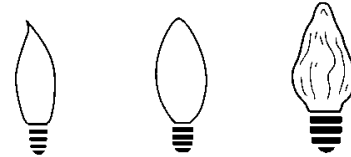

SYL No.	Product Number	Description	Std. Pkg.	Each
25B10C/DL/BL	13316	B10, 25W, clear, cand. base.	12	\$2.17
25G16.5C/BL	13625	G16.5, 25W, clear, cand. base.	12	2.60
25G16.5C/W/BL	13622	G16.5, 25W, white, cand. base.	12	1.03
40B10C/DL/BL/2PK	13319	B10, 40W, clear, cand. base.	12	.88
40B10C/DLF/FL/2P	13320	B10, 40W, frost, cand. base.	6	2.37
40G25/RP	14283	G25, 40W, clear, med. base.	6	1.05
40G25/W/RP	14287	G25, 40W, white, med. base.	6	1.12

NOTE: See page J-18 for longer life, energy saving compact fluorescent retro-fit lamps.

SYLVANIA REFLECTOR FLOODS

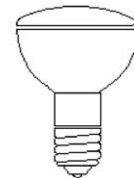

SYL No.	Product Number	Description	Std. Pkg.	Each
30R20/RP	14836	R20, 120V, med. base.	6	\$5.74
50R20/RP	14833	R20, 120V, med. base.	6	11.39
65BR30FLCVP	15172	BR30, 130V, med. base.	6	1.54
75ER30/RP	15100	ER30, 120V, med. base.	24	5.22
120BR/FL	14903	BR40, 120V, med. base.	24	3.48
250BR40/1*	14664	BR40, 120V, med. base.	6	5.70
300PAR56/WFL	14953	PAR56, 120V, mogul base.	12	57.98

*Infrared clear heat lamp.



SHAW SUPPLY COMPANY
 1066 East 16th Street
 816-221-0060
 www.shawsupply.com

SYLVANIA LIGHTING

SYLVANIA QUARTZ TUNGSTEN HALOGEN LAMPS SINGLE END

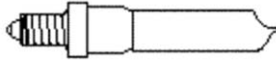

SYL No.	Product Number	Description	Std. Pkg.	Each
150QMCETH	58736	E-11, 150W, Mini can, T-4 base.	12	\$56.21
250QMC	58765	E-11, 250W, Mini can, T-4 base.	12	17.53
500QMC	58768	E-11, 500W, Mini can, T-4 base.	12	17.53

SYLVANIA QUARTZ TUNGSTEN HALOGEN LAMPS DOUBLE END

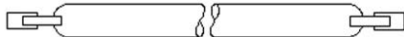

SYL No.	Product Number	Description	Std. Pkg.	Each
300T3QCLRPEHM	58920	300W, 4-11/16" Long.	12	\$8.75
500T3QCL	58997	500W, 4-11/16" long.	12	5.41
1500T3QCL	58857	1500W, 10-1/16" long.	12	12.90
1500T3QCL277	58858	1500W, 10-1/16" long.	12	13.09

SYLVANIA METALARC SUPERSAVER ENERGY SAVING METAL HALIDE RETROFIT

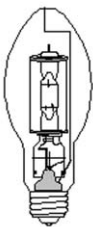

Constructed with an enhanced arc tube for peak performance, Sylvania Metalarc and Metalarc Supersaver lamps are designed as energy saving replacement metal halide lamps. No ballast lamp is required.

150 Watt Supersaver

Saves 25 watts of power and \$25.00 of energy compared to a 175 watt metal halide lamp. Direct retro-fit for 175 watt metal halide lamps; operates on a standard 175 watt M57 CWA ballast.

360 Watt Supersaver

Saves 40 watts of power and \$80.00 of energy compared to a 400 watt metal halide lamp. Direct retro-fit for 400 watt metal halide lamps; operates on a standard 400 watt M50 CWA ballast. Available in Metalarc Pro-Tech lamp design for use in open fixture applications.

SYL No.	Product Number	Description	Std. Pkg.	Each
M150SSUBT28	64719	BT28, 150W, clear, mogul base.	6	\$37.73
MS360SSBUHOR	64655	BT37, 360W, clear, mogul base.	6	29.13
MS360CSSBUHOR	64656	BT37, 360W, coated, mogul base.	6	41.52
MSP360SSBUHOR*	64737	BT37, 360W, clear, mogul base.	6	56.80
MSP360CSSBUONLY*	64738	BT37, 360W, coated, mogul base.	6	60.08

*Open fixture rated (protected).

SYLVANIA METALARC METAL HALIDE METALARC PULSE START — HIGH OUTPUT, LOW WATTAGE

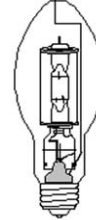

SYL No.	Product Number	Description	Std. Pkg.	Each
MP50UMED	64587	E17, 50W, clear, med. base.	20	\$39.67
MP50CUMED	64588	E17, 50W, coated, med. base.	20	42.39
MP70UMED	64547	E17, 70W, clear, med. base.	20	41.30
MP70CUMED	64546	E17, 70W, coated, med. base.	20	48.13
MP100UMED	64417	E17, 100W, clear, med. base.	20	41.30
MP100CUMED	64118	E17, 100W, coated, med. base.	20	42.98
MP150UMED	64402	E17, 150W, clear, med. base.	20	46.24
MP150CUMED	64406	E17, 150W, coated, med. base.	20	48.13

SYLVANIA METALARC METAL HALIDE METALARC PULSE START — HIGH OUTPUT, HIGH WATTAGE

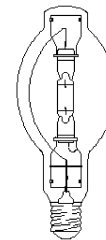

SYL No.	Product Number	Description	Std. Pkg.	Each
MS320PSBUHOR	64507	BT28, 320W, clear, mogul base.	6	\$43.08
MS320CPSBUHOR	64646	BT28, 320W, coated, modul base.	6	43.65
MP320350PSBUONLYBT28*	64391	BT28, 320/350W, clear, mogul base.	6	158.52
MP350CPSBUONLYBT28*	64349	BT28, 320/350W, coated, mogul base.	6	66.56
MP350400PSBUONLY*	64769	BT37, 350/400W, clear, modul base.	6	66.61
MP350400CPSBUONLY*	64770	BT37, 350/400W, coated, mogul base.	6	67.45

*Open fixture rated (protected).

SYLVANIA LIGHTING



SHAW SUPPLY COMPANY

1066 East 16th Street

816-221-0060

www.shawsupply.com

SYLVANIA STANDARD METALARC METAL HALIDE

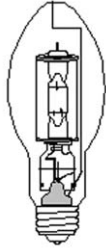

SYL No.	Product Number	Description	Std. Pkg.	Each
M175UMED	64479	E17, 175W, clear, med. base.	20	\$32.06
M175CUMED	64480	E17, 175W, coated, med. base.	20	36.80
M175U	64471	BT28, 175W, clear, mogul base.	6	20.04
M175CU	64472	BT28, 175W, coated, mogul base.	6	25.25
M250U	64457	BT28, 250W, clear, mogul base.	6	20.04
M250CU	64458	BT28, 250W, coated, mogul base.	6	30.10
MP250BUONLY*	64404	BT28, 250W, clear, mogul base.	6	43.09
M400U	64490	BT37, 400W, clear, mogul base.	6	19.10
M400CU	64492	BT37, 400W, coated, mogul base.	6	25.25
M400UBT38	64488	BT28, 400W, clear, mogul base.	6	39.59
M400CUBT28	64489	BT28, 400W, coated, mogul base.	6	51.28
MP400BUONLY*	64705	BT37, 400W, clear, mogul base.	6	41.14
MP400BDONLY*	64717	BT37, 400W, clear, mogul base.	6	58.52
M1000U	64468	BT56, 1000W, clear, mogul base.	6	41.33
M1000CU	64470	BT56, 1000W, coated, mogul base.	6	52.75

*Open fixture rated (protected).

SYLVANIA HIGH PRESSURE SODIUM MEDIUM BASE—CLEAR



SYL No.	Product Number	Description	Std. Pkg.	Each
LU70MED	67504	ET23.5, 70W, med. base.	20	\$19.23
LU100MED	67506	E17, 100W, med. base.	20	20.54
LU15055MED	67508	E17, 150W, med. base.	20	26.65

SYLVANIA HIGH PRESSURE SODIUM MOGUL BASE—CLEAR

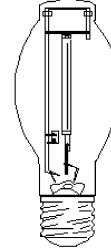

SYL No.	Product Number	Description	Std. Pkg.	Each
LU70ECO	67512	E17, 70W, mogul base.	20	\$19.70
LU100ECO	67514	E17, 100W, mogul base.	20	19.70
LU15055ECO	67516	E17, 150W, mogul base.	20	19.70
LU250ECO	67578	ET18, 250W, mogul base.	20	19.70
LU400ECO	67533	ET187, 400W, mogul base.	20	19.70
LU1000	67307	E25, 1000W, mogul base.	6	62.03

SYLVANIA STANDARD T-8 & T-12 PREHEAT LAMPS



SYL No.	Product Number	Description	Std. Pkg.	Each
F13T8CW	21766	13W, T-8, 12" medium bipin.	62	\$14.44
F15T8CW	21616	15W, T-8, 18", medium bipin.	62	3.21
F15T12CW	21532	15W, T-12, 18" medium bipin.	62	3.47
F20T12CW	22078	20W, T-12, 24", medium bipin.	62	2.46

SYLVANIA RAPID START T-12 LAMPS

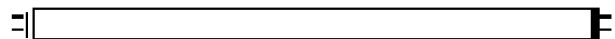

SYL No.	Product Number	Description	Std. Pkg.	Each
F25T12CWRSS	23472	25W, 36", 62 CRI, medium bipin.	30	\$11.29
F34WWSSECO	24538	34W, 48", 52 CRI, medium bipin.	30	2.78
F34CWSSECO	24596	34W, 48", 62 CRI, medium bipin.	30	1.57
FB34CW6SSECO	24054	34W, 22.5" 62 CRI, medium bipin.	12	8.65



SHAW SUPPLY COMPANY
 1066 East 16th Street
 816-221-0060
 www.shawsupply.com

SYLVANIA LIGHTING

SYLVANIA SLIMLINE INSTANT START T-12 LAMPS

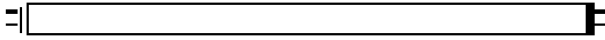

SYL No.	Product Number	Description	Std. Pkg.	Each
F96T12CWSSECO	29505	60W, 96", 62 CRI, single bipin.	15	\$3.58
F96T12WWSSECO	29795	60W, 96", 62 CRI, single bipin.	15	14.53

SYLVANIA RAPID START HIGH OUTPUT T-12 LAMPS

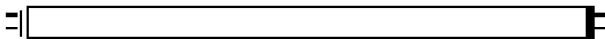

SYL No.	Product Number	Description	Std. Pkg.	Each
F96T12CWHOSSECO	25001	800ma.	15	\$4.87

SYLVANIA PENTRON HIGH PERFORMANCE T-5 FLUORESCENT LAMPS

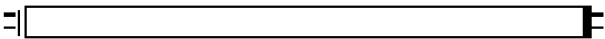

SYL No.	Product Number	Description	Std. Pkg.	Each
FP21830ECO	20919	21W, 36", 3000k, 83CRI, mini base.	40	\$15.39
FP21835ECO	20921	21W, 36", 3500k, 83CRI, mini base.	40	15.39
FP21841ECO	20924	21W, 36", 4100k, 83CRI, mini base.	40	15.39
FP28830ECO	20868	28W, 36", 3000k, 83CRI, mini base.	40	8.51
FP28835ECO	20901	28W, 36", 3500k, 83CRI, mini base.	40	13.26
FP28841ECO	20902	28W, 36", 4100k, 83CRI, mini base.	40	13.26
FP54830HOECO	20903	54W, 48", 3000k, 83CRI, mini base.	40	11.35
FP54835HOECO	20904	54W, 48", 3500k, 83CRI, mini base.	40	11.35
FP54841HOECO	20906	54W, 48", 4100k, 83CRI, mini base.	40	11.35

SYLVANIA OCTRON T-8 FLUORESCENT LAMPS

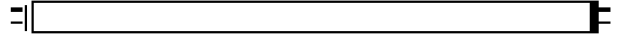

SYL No.	Product Number	Description	Std. Pkg.	Each
FO17735ECO	21769	17W, 24", 3500k, 75 CRI.	30	\$3.21
FO17741ECO	21770	17W, 24", 4100k, 75 CRI.	30	3.21
FO25735ECO	21941	25W, 36", 3500k, 75 CRI.	30	3.21
FO25741ECO	21942	25W, 36", 4100k, 75 CRI.	30	3.21
FO28830XPSS*	22177	28W, 48", 3000k, 82 CRI.	30	5.28
FO28835XPSS*	22178	28W, 48", 3500k, 82 CRI.	30	5.28
FO28841XPSS*	22179	28W, 48", 4100k, 82 CRI.	30	5.28
FO32730ECO	21997	32W, 48", 3000k, 75 CRI.	30	1.97
FO32735ECO	21998	32W, 48", 3500k, 75 CRI.	30	1.97
FO32741ECO	21999	32W, 48", 4100k, 75 CRI.	30	1.97
FO32750ECO	22141	32W, 48", 5000k.	30	2.85
FO32830ECO	21777	32W, 48", 3000k, 82 CRI.	30	3.04
FO32835ECO	21779	32W, 48", 3500k, 82 CRI.	30	3.04
FO32841ECO	21781	32W, 48", 4100k, 82 CRI.	30	3.04
FO32850ECO	22143	32W, 48", 5000k, 80 CRI.	30	3.24
FB327306ECO	22046	32W, 22.5", 3000k, 75 CRI.	16	9.38
FB327356ECO	22051	32W, 22.5", 3500k, 75 CRI.	16	10.34
FP0327416ECO	22052	32W, 22.5", 4100k, 75 CRI.	16	10.34
FB0328306ECO	21663	32W, 22.5", 3000k, 82 CRI.	16	12.12
FB0328356ECO	21670	32W, 22.5", 3500k, 82 CRI.	16	11.24
FB0328416ECO	21671	32W, 22.5", 4100k, 82 CRI.	16	30.47
FO96735ECO	21737	59W, 96", 3500k, 75 CRI, single pin base.	24	9.38
FO96741ECO	21736	59W, 96", 4100k, 75 CRI, single pin base.	24	8.78
FO96735HO	22204	86W, 96", 3500k, 84 CRI, res. DC base.	24	12.53
FO96741HO	22205	86W, 96", 4100k, 84 CRI, res. DC base.	24	12.55

*Super Saver ECO. Fluorescent lamps are direct, energy saving, longer life replacements for standard T8 lamps on instant start systems providing up to 12% energy savings and up to 20% longer life

SYLVANIA LIGHTING



SHAW SUPPLY COMPANY

1066 East 16th Street

816-221-0060

www.shawsupply.com

**SYLVANIA COMPACT FLUORESCENT LAMPS
DULUX 4-PIN PRE-HEAT—DIMMING & ELECTRONIC BALLASTS**

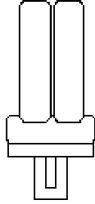

SYL No.	Product Number	Description	Std. Pkg.	Each
CF13DDE830	20721	T4, 13W, Dulux Double, med. base, color 3000, 12,000 hrs.	50	\$10.81
CF13DDE835	20671	T4, 13W, Dulux Double, med. base, color 3500, 12,000 hrs.	50	7.38
CF13DDE841	20667	T4, 13W, Dulux Double, med. base, color 4100, 12,000 hrs.	50	7.38
CF18DDE835	20672	T4, 18W, Dulux Double, med. base, color 3500, 12,000 hrs.	50	8.24
CF18DDE841	20668	T4, 18W, Dulux Double, med. base, color 4100, 12,000 hrs.	50	9.56
CF26DDE835	20673	T4, 26W, Dulux Double, med. base, color 3500, 12,000 hrs.	50	8.54
CF26DDE841	20669	T4, 26W, Dulux Double, med. base, color 4100, 12,000 hrs.	50	8.54

**SYLVANIA COMPACT FLUORESCENT LAMPS
DULUX 2-PIN PRE-HEAT—USE WITH MAGNETIC BALLAST**

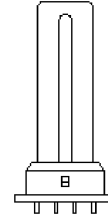

SYL No.	Product Number	Description	Std. Pkg.	Each
CF9DS835	20333	T4, 9W, Dulux Single, med. base, color 3500, 10,000 hrs.	50	\$2.86
CF9DS841	20305	T4, 9W, Dulux Single, med. base, color 4100, 10,000 hrs.	50	2.86
CF13DS835	20335	T4, 13W, Dulux Single, med. base, color 4100, 10,000 hrs.	50	2.61
CF13DS841	20306	T4, 13W, Dulux Single, med. base, color 4100, 10,000 hrs.	50	2.61
CF13DD835	20692	T4, 13W, Dulux Double, med. base, color 4100, 10,000 hrs.	50	7.71
CF13DD841	20708	T4, 13W, Dulux Double, med. base, color 4100, 10,000 hrs.	50	7.38
CF18DD835	20677	T4, 18W, Dulux Double, med. base, color 3500, 10,000 hrs.	50	8.38
CF18DD841	20678	T4, 18W, Dulux Double, med. base, color 4100, 10,000 hrs.	50	9.24
CF26DD835	20680	T4, 26W, Dulux Double, med. base, color 3500, 10,000 hrs.	50	8.25
CF26DD841	20681	T4, 26W, Dulux Double, med. base, color 4100, 10,000 hrs.	50	8.83

**SYLVANIA COMPACT FLUORESCENT LAMPS
DULUX T/E/IN AMALGAM 4-PIN
FOR DIMMING & ELECTRONIC BALLASTS FOR HIGH & LOW
TEMPERATURES**

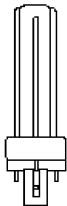

SYL No.	Product Number	Description	Std. Pkg.	Each
CF18DTEIN835	20877	T4, 18W, Dulux Triple, med. base, color 3500, 12,000 hrs.	50	\$11.81
CF26DTEIN835	20881	T4, 26W, Dulux Triple, med. base, color 3500, 12,000 hrs.	50	13.63
CF32DTEIN835	20885	T4, 32W, Dulux Triple, med. base, color 3500, 12,000 hrs.	50	12.31
CF32DTEIN841	20886	T4, 32W, Dulux Triple, med. base, color 4100, 12,000 hrs.	50	13.79
CF42DTEIN835	20871	T4, 42W, Dulux Triple, med. base, color 3500, 12,000 hrs.	50	13.47
CF42DTEIN841	20890	T4, 42W, Dulux Triple, med. base, color 4100, 12,000 hrs.	50	15.09